

# SKR - industry relay



## the universal relay SKR

The strengths of the SKR industry relay lie in the mature and thought-out construction.

Over-average contact safety and life time, electrical and mechanical status indication as well as the unsurpassed construction from only six assemblies makes the relay to the excellent power switch.

## the time module STM

8 adjustable functions and 8 selectable time ranges: these are the special features of the time module STM. With only one version of the module all essential features as operating voltage, functions and time ranges are adjustable.

The result: a simple and cost-effective warehousing.

## the socket

Simple to handle screw-terminal and clear, rich in contrast labeled clamp identification, are the base for a problemless use.

The ZKE/ZKX sockets permit a rapid and secure installation.

The separated inputs and outputs are located at one level. There is also the possibility to plug a time module STM or other additional modules together with the SKR relay.

## features

- simple construction
- high contact load
- contact spring in Beryllium bronze
- safe wire diameter
- long life time
- large coil room
- electrical or mechanical status indication
- integrated manual actuation
- simple installation
- indelible scheme on socket or cover following international standards

## applications

- mostly used where a time-dependent event must be headed
- switch panel making
- machine industry
- illuminations
- locking of functions
- gate control
- machine control

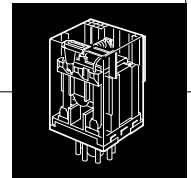

**type number key**

**SKR 115 A ... 024VDC**

**coil voltage**

VDC = direct current  
VAC = alternating current

**standard voltage**

VAC: 024, 115, 230 V  
VDC: 024, 110

**options**

D = double contact (AgCuNi)  
L = electrical position indication  
F = free wheel diode  
FL = free wheel diode and  
electrical position indication  
B = without manual actuation  
T = push-button actuation  
C = current coil

**relay version**

SKR 085 A  
SKR 115 A  
SKR 122 A

A = mechanical position indication  
standard: manual actuation

**order samples**

manual actuation	position indication	free wheel diode	LED display						
•	•			SKR085 A	VDC/AC	SKR115 A	VDC/AC	SKR122 A	VDC/AC
•	•	•		SKR085 AF	VDC	SKR115 AF	VDC	SKR122 AF	VDC
•	•		•	SKR085 AL	VDC/AC	SKR115 AL	VDC/AC	SKR122 AL	VDC/AC
•	•	•	•	SKR085 AFL	VDC	SKR115 AFL	VDC	SKR122 AFL	VDC



# SKR085 - industry relay, 8-pole



Industry relay with two change-over contacts in different versions.

## order numbers

serial version	SKR 085 A ...
	VDC/AC
with mechanical position indication	

## contact specifications

contact material	AgCuNi
contact type	single contact
nominal switching capacity	250 VAC 10 A AC1 2500 VA 440 VAC 4 A AC1
electric life expectancy	app. 700'000 operations 250 VAC, 10 A, AC1 (360 operations/h)
inrush current max.	40 A for 200 ms
switching current range	50 mA to 10 A
switching power range	0,3 VA(W) to 2500 VA

## options

electrical	
position indication	SKR 085 L ..
with free wheel diode	SKR 085 F ..
electrical	
position indication	
with free wheel diode	SKR 085 FL ..
double contact	SKR 085 D ..
without manual	
actuation	SKR 085 B ..
push-button actuation	SKR 085 T ..
current coil	SKR 085 C ..

(combinations with mechanical and electrical position indication and free-wheel diode are possible)

## general data

mechanic life expectancy	> 10 <sup>8</sup> operations
mechanical switching frequency	20 Hz
pull-in time	12 ms at DC / 3-10 ms at AC
release time	3,5 ms at DC / 2-15 ms at AC
bounce time normally open contact	3,5 ms at DC / 3-6 ms at AC
bounce time break contact	9 ms at DC / 6-11 ms at AC
shock resistance	AK: > 10 g
vibration resistance	10-55 Hz, AK: 10 g, RK: 3 g
test voltage, coil/contact	2500 V <sub>eff</sub>
test voltage, open contact	1500 V <sub>eff</sub>
insulation resistance	10 <sup>12</sup> Ohm
weight	app. 80 g
installation situation	any
ambient temperature	max. +70 °C
protection standard	IP 40

## accessories

plug-in socket	ZVE 8
	ZKE 088
metal clamp	ZKR 008

## tests, instructions

certificates	UL, CSA, VDE
insulation group	VDE 0110 / group C 250 VAC

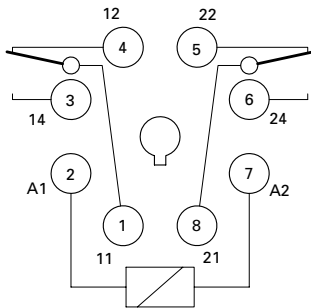
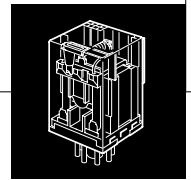

circuit diagram

**dimensions**

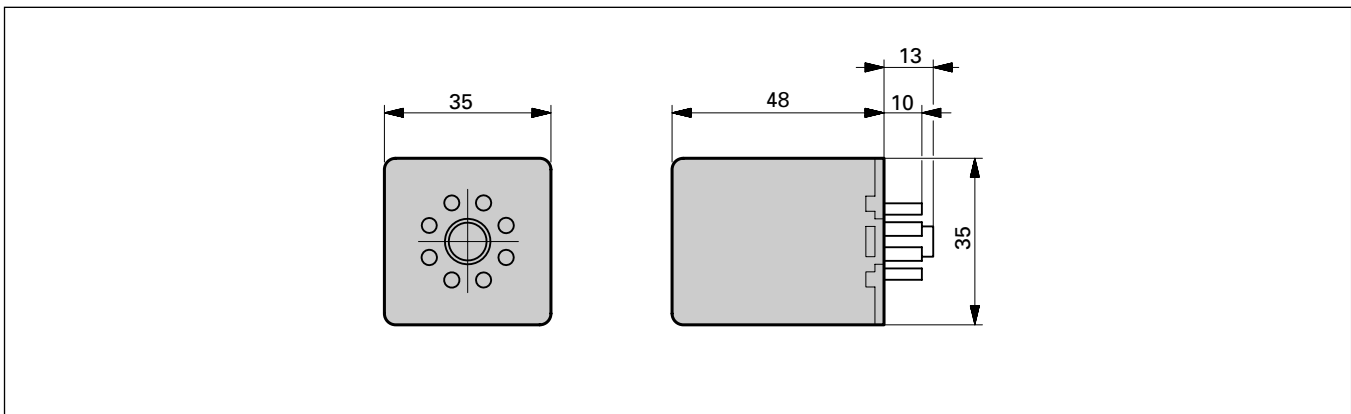

**coil specifications**

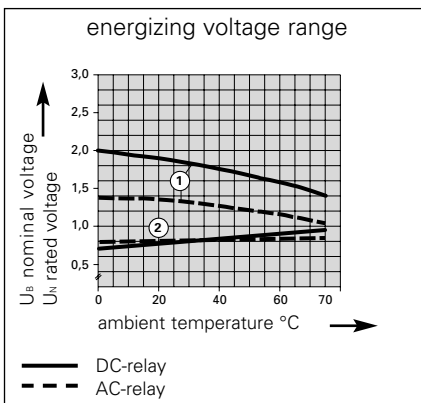

standard coils for direct current (other voltages on enquiry)

rated voltage VDC	pull-in voltage at 20 °C	reset voltage at 20 °C	nominal current mA	resistance Ohm at 20 °C	tolerance %
12	9,6	≥ 0,6	104	115	+/-10
24	19,2	≥ 1,2	50,0	480	+/-10
48	38,4	≥ 2,4	25,9	1850	+/-10
110	88,0	≥ 5,5	12,2	9'000	+/-15
220	176,0	≥ 11	7,58	29'000	+/-15

standard coils for alternated current (other voltages on enquiry)

VAC	pull-in voltage at 20 °C	reset voltage at 20 °C	nominal current mA	resistance Ohm at 20 °C	tolerance %
12	9,6	≥ 0,6	211	13,3	+/-10
24	19,2	≥ 1,2	104	52	+/-10
48	38,4	≥ 2,4	55	240	+/-10
110	88,0	≥ 5,5	23	1'120	+/-10
220	176	≥ 11,0	12,0	4'450	+/-10
230	184	≥ 11,5	11,5	5'600	+/-10

- single relay, no heat concentration by surrounding components with self-heating.
  - on time 100%
- 1) max. energizing voltage without contact load
  - 2) min. energizing voltage (guaranteed value), without operation in advance.



# SKR115 - industry relay, 11-pole



Industry relay with three change-over contacts in different versions

## order numbers

serial version SKR 115 A ...  
VDC/AC  
with mechanical position indication

## contact specifications

contact material	AgCuNi
contact type	single contact
nominal switching capacity	250 VAC 10 A AC1 2500 VA 440 VAC 4 A AC1
electric life expectancy	app. 700'000 operations 250 VAC, 10 A, AC1 (360 operations/h)
max. inrush current	40 A for 200 ms
switching current range	50 mA to 10 A
switching power range	0,3 VA to 2500 VA

## options

electrical position indication SKR 115 L ..  
with free wheel diode SKR 115 F ..  
electrical position indication  
with free wheel diode SKR 115 FL ..  
double contact SKR 115 D ..  
without manual  
actuation SKR 115 B ..  
push-button actuation SKR 115 T ..  
current coil SKR 115 C ..

(combinations with mechanical and electrical position indication and free-wheel diode are possible)

## general data

mechanic life expectancy	> 10 <sup>8</sup> operations
mechanical switching frequency	20 Hz
pull-in time	12 ms at DC / 3-10 ms at AC
release time	3,5 ms at DC / 2-15 ms at AC
bounce time normally open contact	3,5 ms at DC / 3-6 ms at AC
bounce time break contact	9 ms at DC / 6-11 ms at AC
shock resistance	AK: > 10 g
vibration resistance	10-55 Hz, AK: 10 g, RK: 3 g
test voltage, coil/contact	2500 V <sub>eff</sub>
test voltage, open contact	1500 V <sub>eff</sub>
insulation resistance	10 <sup>12</sup> Ohm
weight	app. 80 g
installation situation	any
ambient temperature	max. +70 °C
protection standard	IP 40

## accessories

plug-in socket ZVE 11  
ZKE 118  
ZKX 118  
time module STM 100  
metal clamp ZKR 008

## tests, instructions

certificates UL, CSA, VDE  
insulation group VDE 0110 / group C 250 VAC

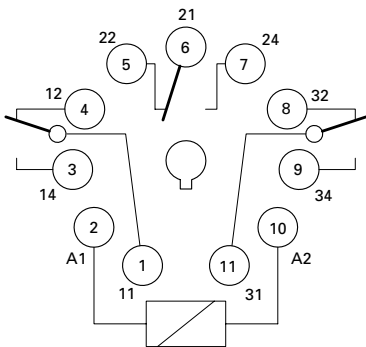
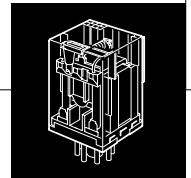

circuit diagram

### dimensions

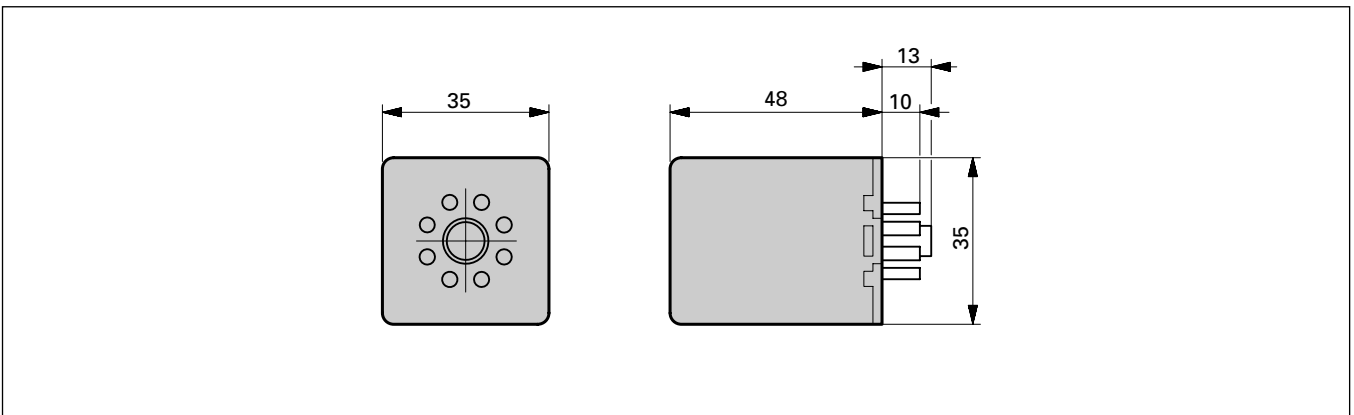

### coil specifications

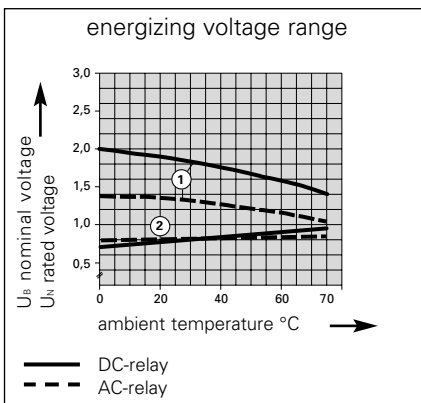

standard coils for direct current (other voltages on enquiry)

rated voltage VDC	pull-in voltage at 20 °C	reset voltage at 20 °C	nominal current mA	resistance Ohm at 20 °C	tolerance %
12	9,6	≥ 0,6	104	115	+/-10
24	19,2	≥ 1,2	50,0	480	+/-10
48	38,4	≥ 2,4	25,9	1850	+/-10
110	88,0	≥ 5,5	12,2	9'000	+/-15
220	176,0	≥ 11	7,58	29'000	+/-15

standard coils for alternated current (other voltages on enquiry)

VAC					
12	9,6	≥ 0,6	211	13,3	+/-10
24	19,2	≥ 1,2	104	52	+/-10
48	38,4	≥ 2,4	55	240	+/-10
110	88,0	≥ 5,5	23	1'120	+/-10
220	176	≥ 11,0	12,0	4'450	+/-10
230	184	≥ 11,5	11,5	5'600	+/-10

- single relay, no heat concentration by surrounding components with self-heating.
- on time 100%

- 1) max. energizing voltage without contact load
- 2) min. energizing voltage (guaranteed value), without operation in advance.



# SKR122 - industry relay, PCB version



Industry relay with three change-over contacts in different versions

## order numbers

serial version	SKR 122 A ...
	VDC/AC
with mechanical position indication	

## contact specifications

contact material	AgCuNi
contact type	single contact
nominal switching capacity	250 VAC 10 A AC1 2500 VA 440 VAC 4 A AC1
electric life expectancy	app. 700'000 operations 250 VAC, 10 A, AC1 (360 operations/h)
max. inrush current	40 A for 200 ms
switching current range	50 mA to 10 A
switching power range	0,3 VA to 2500 VA

## options

electrical	
position indication	SKR 122 L ..
with free wheel diode	SKR 122 F ..
electrical	
position indication	
with free wheel diode	SKR 22 FL ..
double contact	SKR 122 D ..
without manual	
actuation	SKR 122 B ..
push-button actuation	SKR 122 T ..
current coil	SKR 122 C ..

(combinations with mechanical and electrical position indication and free-wheel diode are possible)

## general data

mechanic life expectancy	> 10 <sup>8</sup> operations
mechanical switching frequency	20 Hz
pull-in time	12 ms at DC / 3-10 ms at AC
release time	3,5 ms at DC / 2-15 ms at AC
bounce time normally open contact	3,5 ms at DC / 3-6 ms at AC
bounce time break contact	9 ms at DC / 6-11 ms at AC
shock resistance	AK: > 10 g
vibration resistance	10-55 Hz, AK: 10 g, RK: 3 g
test voltage, coil/contact	2500 V <sub>eff</sub>
test voltage, open contact	1500 V <sub>eff</sub>
insulation resistance	10 <sup>12</sup> Ohm
weight	app. 80 g
installation situation	any
ambient temperature	max. +70 °C

## accessories

PCB socket	ZKR 003
metal clamp	ZKR 008

## tests, instructions

certificates	UL, CSA, VDE
insulation group	VDE 0110 / group C 250 VAC

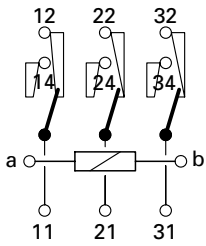
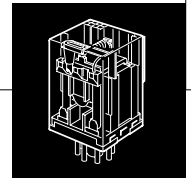

circuit diagram

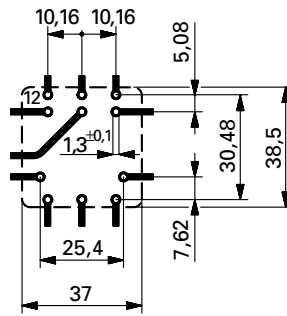

drilling plan (view on solder side)

**dimensions**

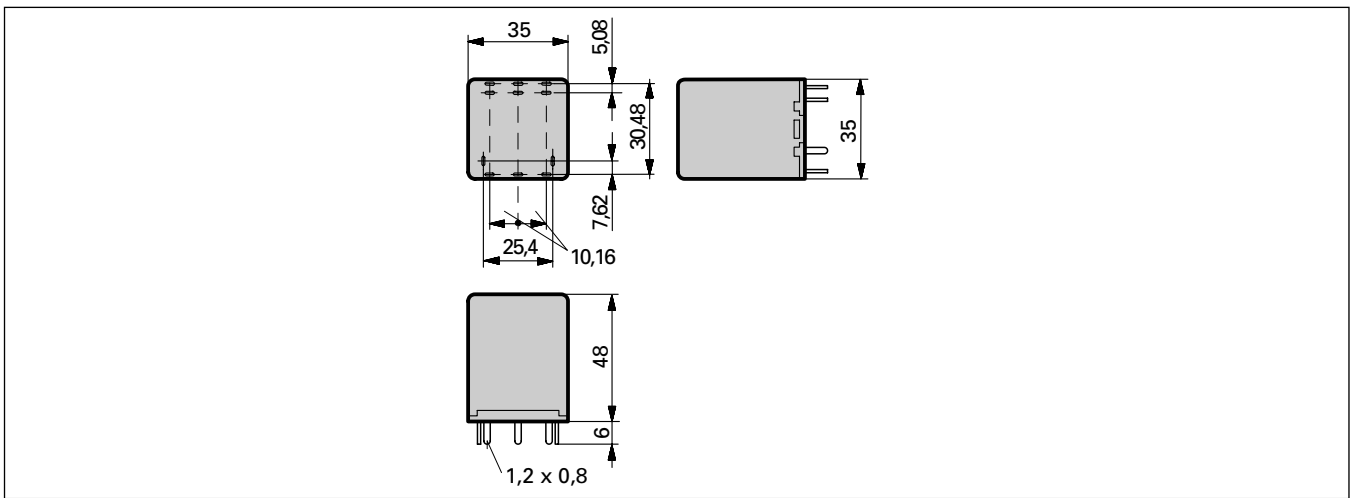

**coil specifications**

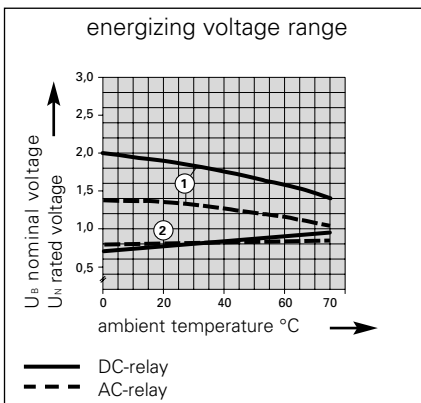

standard coils for direct current (other voltages on enquiry)

rated voltage VDC	pull-in voltage at 20 °C	reset voltage at 20 °C	nominal current mA	resistance Ohm at 20 °C	tolerance %
12	9,6	≥ 0,6	104	115	+/-10
24	19,2	≥ 1,2	50,0	480	+/-10
48	38,4	≥ 2,4	25,9	1850	+/-10
110	88,0	≥ 5,5	12,2	9'000	+/-15
220	176,0	≥ 11	7,58	29'000	+/-15

standard coils for alternated current (other voltages on enquiry)

VAC					
12	9,6	≥ 0,6	211	13,3	+/-10
24	19,2	≥ 1,2	104	52	+/-10
48	38,4	≥ 2,4	55	240	+/-10
110	88,0	≥ 5,5	23	1'120	+/-10
220	176	≥ 11,0	12,0	4'450	+/-10
230	184	≥ 11,5	11,5	5'600	+/-10

- single relay, no heat concentration by surrounding components with self-heating.
- on time 100%

- 1) max. energizing voltage without contact load
- 2) min. energizing voltage (guaranteed value), without operation in advance.



# SKR-contact specifications

## AgCuNi single contact

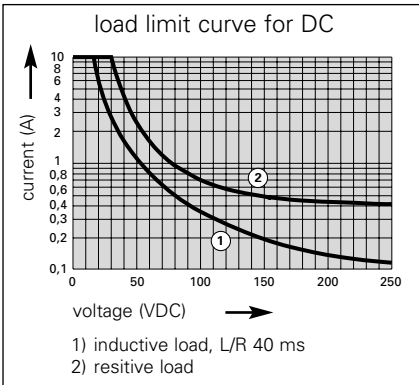

data valid for relay

contact material  
contact type  
nominal switching capacity  
electric life expectancy  
max. inrush current  
switching current range  
switching power range  
contact resistance

SKR 085 SKR 115 SKR 122
AgCuNi (Ag1,88 Ni0,12)
single contact
250 VAC 10 A AC1 2500 VA 440 VAC 4 A AC1 1600 VA
app. 700'000 operations 250 VAC 10 A AC1 (360 operations/h)
40 A for 20 ms
30 mA to 10 A
0,18 VA to 2500 VA
20 mΩ

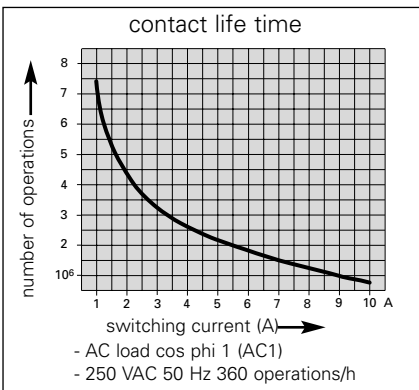

## AgCuNi double contact

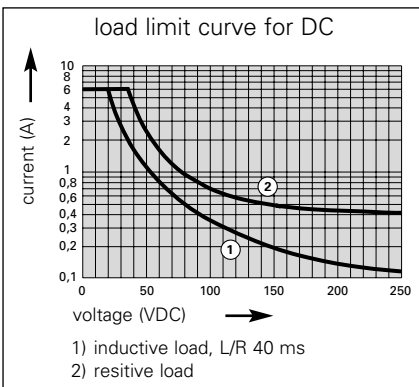

data valid for relay

contact material  
contact type  
nominal switching capacity  
electric life expectancy  
max. inrush current  
switching current range  
switching power range  
contact resistance

SKR 085D SKR 115D SKR 122D
AgCuNi (Ag1,88 Ni0,12)
double contact
250 VAC 6 A AC1 1500 VA
app. 150'000 operations 250 VAC 6 A AC1 (360 operations/h)
15 A für 20 ms
10 mA to 6 A
0,06 VA to 1500 VA
10 mΩ

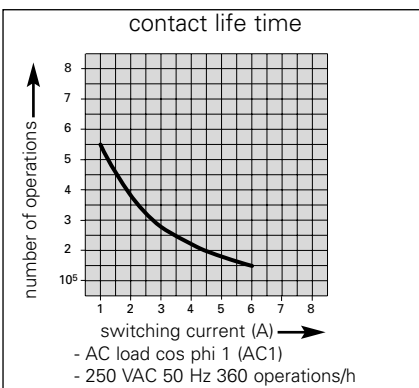

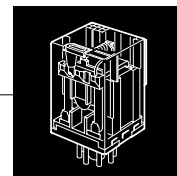

ZKR 003 matching to SKR 122

## order numbers

ZKR 003

## general data

nominal data	max. 10 A 400 V
test voltage	2000 V <sub>eff</sub>
contact spring material	Ms improved
fixing	soldering pin 1 x M3
creeping resistance	CTI 250
weight	app. 7 g
installation situation	any
ambient temperature	-40 to +85 °C
number of poles	11-pole
protection standard	IP 30

## accessories

metal clamp  
ZKR 008

## tests, instructions

certificates	UL, CSA
insulation group	VDE 0110 / group C 250 VAC

## dimensions

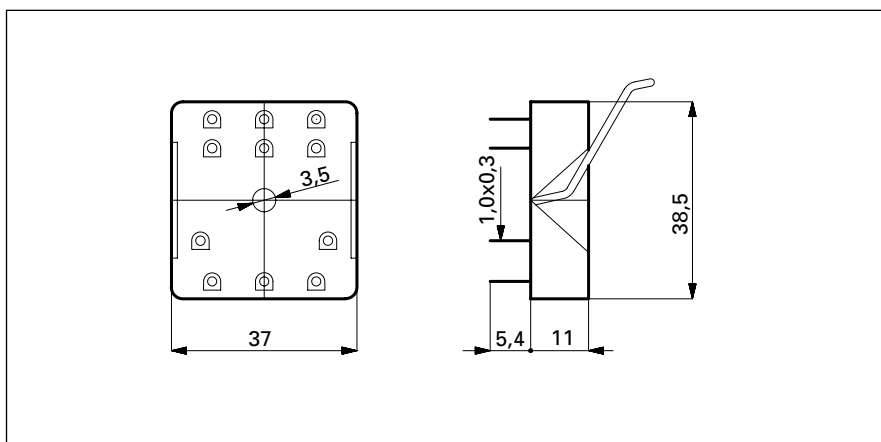

## drilling plan

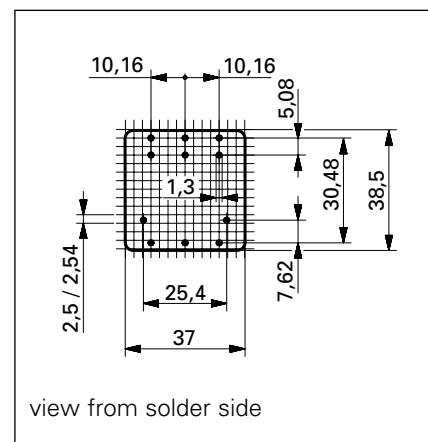

# SKR-screw socket with accessories

## socket

ZVE8



ZKE088

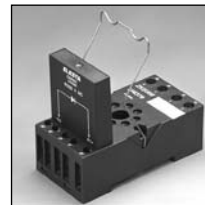

## data

nominal data		400 VAC 10 A	400 VAC 10 A
dimensions (L x B x H)	[mm]	57 x 38 x 28,5	75 x 38 x 26
ambient temperature	[°C]	-40 to +85	-40 to +85

## accessories

plug-in modules			E...
time module			STM 100
metal clamp		ZKR008	ZKR008

ZVE11



ZKX118

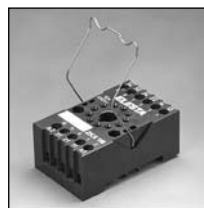

ZKE118



## data

nominal data		400 VAC 10 A	400 VAC 10 A	400 VAC 10 A
dimensions (L x B x H)	[mm]	57 x 38 x 28,5	62 x 38 x 26	75 x 38 x 26
ambient temperature	[°C]	-40 to +85	-40 to +85	-40 to +85

## accessories

plug-in modules				E...
time modules				STM 100
metal clamp		ZKR008	ZKR008	ZKR008

## tests, instructions

certificates		UL, CSA
insulation group		VDE 0110 / group C 250 VAC

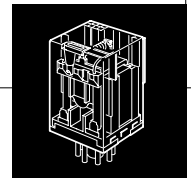

## time modules

### STM 100



### data

compatible to socket	ZKE088/118
function	programmable
time range	0,05s - 240h
rated voltage	24 - 240 VDC/VAC

### general data

time range	8 ranges: 1s, 10s, 1m, 10m, 1h, 10h, 1d, 10d
time adjustment	variable, 5% - 100% of the time range
time function	8 functions, selectable by DIP switches
display	green LED for ON-status, blinking at time delay
dimensions	B x H x T = 35 x 46,7 x 10,3 mm (without clamp)
weight	app. 14 g
permissible ambient temperature	-25 to +55 °C
nominal voltage	24V to 240V AC (-15%...+10%) , 24V to 250V DC (-15%...+10%)
frequency	48 Hz to 63 Hz
max. power consumption	24V AC/DC: 70mW , 240V AC/DC: 700mW
min. impulse time (B1)	AC: 50ms, DC: 30 ms
min. pause time (B1)	AC&DC: 100ms at 25°C, AC&DC: 140ms at 55°C
pull-in delay	AC: max. 40ms, DC: 20ms
reset time delay	AC&DC: max. 100ms at 25°C, AC&DC: max. 140ms at 55°C
control voltage	24V: min. 80% of supply voltage 230V: min. 95% of supply voltage
time delay after power loss	max. 10ms
start-up time	60ms
re-readiness time	max. 100ms at 25°C, max. 150ms at 55°C
reset at	UN ≤ 10V <sub>eff</sub>
precision at the scale stops	±0,5%
repeatability	<0,5% or 5ms (in % from scale value)
accuracy in adjustment	≤5%
temperature influence	≤0,01% / °C
voltage influence	≤0,001% / V
max. load current	100mA at 25°C

## plug-in modules

### E...

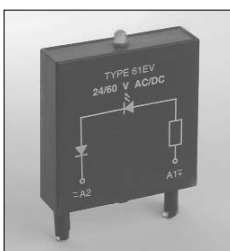

### data

compatible to socket	ZKE088/118
free wheel diode	6 - 220 VDC E 21
RC-circuit	110 - 230 VAC E 51C
varistor	6 - 24 VAC E 71
varistor	6 - 230 VAC E 81
LED	24 - 60 VDC/ VAC E 61EV
LED	110 - 230 VDC/ VAC E 91V

